

L2 Series

Electrodynamic Loudspeakers

USER MANUAL

9L2

11L2

12L2

21L2

22L2

L2 Centre

L2 Sub

Quad Electroacoustics Ltd.
IAG House, Sovereign Court,
Ermine Business Park,
Huntingdon PE29 6XU. England.
Tel : 0845 458 0011 / +44 (0) 1480 447700
Fax : +44 (0) 1480 431767
www.quad-hifi.co.uk

User Cautions



This symbol indicates that there are important operating and maintenance instructions in the literature accompanying this unit.



This symbol indicates that dangerous voltage constituting a risk of electric shock is present within this unit.

IMPORTANT SAFETY INFORMATION

Read these instructions.

Keep these instructions.

Heed all warnings.

Follow all instructions.

Do not use this apparatus near water.

Clean only with dry cloth.

Do not block any ventilation openings.

Install in accordance with the manufacturer's instructions.

Do not install near any heat sources such as radiators, heat registers, stoves, or other apparatus (including amplifiers) that produce heat.

Do not defeat the safety purpose of the polarized or grounding type plug. A polarized plug has two blades with one wider than the other. A grounding type plug has two blades and a third grounding prong. The wider blade or the third prong are provided for your safety. If the provided plug does not fit into your outlet, consult an electrician for replacement of the obsolete outlet.

Protect the power cord from being walked on or pinched, particularly at plugs, convenience receptacles, and the point where they exit from the apparatus.

Use only attachments/accessories specified by the manufacturer.



Use only with a cart, stand, tripod, bracket, or table specified by the manufacturer, or sold with the apparatus. When a cart is used, use caution when moving the cart/apparatus combination to avoid injury from tip-over.

Unplug this apparatus during lightning storms or when unused for long periods of time.

Refer all servicing to qualified service personnel. Servicing is required when the apparatus has been damaged in any way, such as power-supply cord or plug is damaged, liquid has been spilled or objects have fallen into the apparatus, the apparatus has been exposed to rain or moisture, does not operate normally, or has been dropped.

Warning: To reduce the risk of fire or electrical shock, do not expose this product to rain or moisture. The product must not be exposed to dripping and splashing and no object filled with liquids - such as a vase of flowers - should be placed on the product.

No naked flame sources such as candles should be placed on the product.

Caution: Changes or modifications not expressly approved by the manufacturer could void the user's authority to operate this device.

Warning Quad L2 Subwoofer: The mains power switch for this appliance is located on the rear panel. To permit free access to this switch, the apparatus must be located in an open area without any obstructions.

NOTE: Quad L2 Subwoofer:

This equipment has been tested and found to comply with the limits for a Class B digital device, pursuant to part 15 of the FCC Rules. These limits are designed to provide reasonable protection against harmful interference in a residential installation.

This equipment generates, uses and can radiate radio frequency energy and, if not installed and used in accordance with the instructions, may cause harmful interference to radio communications. However, there is no guarantee that interference will not occur in a particular installation. If this equipment does cause harmful interference to radio or television reception, which can be determined by turning the equipment off and on, the user is encouraged to try to correct the interference by one or more of the following measures:

- Reorient or relocate the receiving antenna.
- Increase the separation between the equipment and receiver.
- Connect the equipment into an outlet on a circuit different from that to which the receiver is connected.
- Consult the dealer or an experienced radio/TV technician for help.

IMPORTANT NOTICE TO UK USERS

The power cord on your L2 subwoofer may be supplied with a plug incorporating a fuse, the value of which is indicated on the pin face of the plug. Should the fuse need to be replaced, an ASTA or BSI approved BS1362 fuse must be used of the same rating. If the plug is cut off it must NOT be re-used. Dispose of any such plug safely. There is a danger of electric shock if a cut-off plug is inserted into a mains socket.

Connecting a Mains Plug

The wires in the mains lead are coloured in accordance with the code: Blue: NEUTRAL, Brown:

LIVE:

As these colours may not correspond to the coloured markings identifying the terminals in your plug, proceed as follows:

The BLUE wire must be connected to the terminal marked with the letter N or coloured BLUE or BLACK.

The BROWN wire must be connected to the terminal marked with the letter L or coloured BROWN or RED.

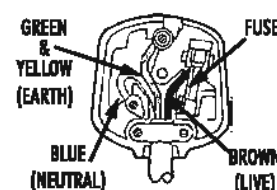

L2 Series

L2 Series

The Closest Approach

Quad - The Closest Approach by Ken Kessler

A 240 page hard-back, authoritative history with commentaries and contributions from every corner of the hi-fi industry. Technical chapters from Tim De Paravicini and Gordon Hill and interviews with Peter Walker, Ross Walker, Stan Curtis and Mike Albinson. Along with a series of stunning new photographs, fascinating historic documents and reproductions of AES and other technical papers, this is the definitive guide to the history and achievements of Quad.

Available through all good book retailers or any of our Dealers, from the Hi-Fi News Accessory Club, the Hi-Fi Collective, or the Quad Service Department

ISBN number 0-9545742-0-6



Introduction



For over 50 years Quad Electroacoustics has produced the most accurate and neutral loudspeakers in the world.

The L2 Series represents the latest evolution of the highly acclaimed Quad electrodynamic series. Redesigned and re-engineered using the most up to date materials and processes, these new evocations of our design philosophy achieve levels of detail, clarity and perspective that will be a revelation and source of continuing delight to all music lovers.

The L2 Series encompasses the entire gamut. Ranging from the diminutive 9L2 through to the impressive floorstanding 22L2, each loudspeaker has been designed from the 'ground up'. The result is a loudspeaker range of impeccable style and one which will be welcomed by audiophiles who value the clear natural sound that is uniquely the hallmark of all QUAD products.

Contents

QUAD L2 SERIES - GENERAL INTRODUCTION	
CAUTIONS	IFC
INTRODUCTION	1
GOOD PRACTICE GUIDE	2
QUAD L2 PASSIVE LOUDSPEAKERS	
WHAT'S IN THE BOX	3
UNPACKING THE EQUIPMENT	3
POSITIONING THE LOUDSPEAKERS	5
CONNECTIONS AND TERMINALS	7
CONNECTING STEREO LOUDSPEAKERS	8
CONNECTING EFFECTS LOUDSPEAKERS	9
SETTING UP A HOME THEATRE SYSTEM	10
THE QUAD L2 SUBWOOFER	
INTRODUCTION	12
WHAT'S IN THE BOX	12
PREPARING THE SUBWOOFER	13
POSITIONING THE SUBWOOFER	15
CONNECTING THE SUBWOOFER	16
CONNECTING TO QUAD AMPLIFICATION	17
OPERATION	19
SETTING UP YOUR SUBWOOFER	20
USING TWO SUBWOOFERS	22
QUAD L2 SERIES - CONCLUSION	
TROUBLESHOOTING	24
SERVICE AND WARRANTY	25
SPECIFICATIONS	26
THE CLOSEST APPROACH	28

L2 Series

Specifications

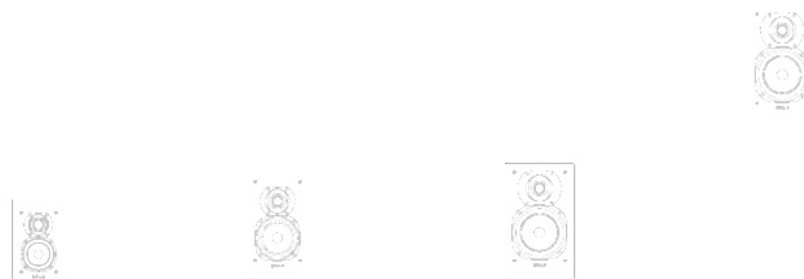

	9L2	11L2	12L2	21L2
Transducer Complement	2 Way	2 Way	2 Way	2 Way
Cone Bass driver	4" 100mm	5" 125mm	6.5" 170mm	6.5" 170mm
Cone Bass/Mid Driver				
Soft Dome Tweeter	1" 25mm	1" 25mm	1" 25mm	1" 25mm
Nominal impedance	6 Ohms*	6 Ohms*	6 Ohms*	6 Ohms*
Frequency response +/- 6dB	50Hz-28kHz	45Hz-28kHz	45Hz-28kHz	35Hz-28kHz
Upper frequency limit -10dB	32kHz	32kHz	32kHz	32kHz
SPL 1W @ 1m	86dB	86dB	88dB	88dB
Power Handling				
Continuous Programme	75 Watts	85 Watts	100 Watts	125 Watts
Recommended Amplifier Power	30-120W	30-150W	30-200W	40-200W
Enclosure type bass/mid	ported	ported	ported	ported
System Fb	60Hz	55Hz	50Hz	40Hz
Crossover frequencies	2.0kHz	2.2kHz	2.2kHz	2.2kHz
Construction material	15 & 25mm MDF	15 & 25mm MDF	15 & 25mm MDF	15 & 25mm MDF
Finish (all models)	Piano finish wood veneers of cherry, rosewood, birds eye maple; plus piano black and piano silver			
Component part numbers				
Bass driver	D687	D688	D689	D689
Bass/Mid Driver				
Tweeter	D695A	D695	D695B	D695B
Product dimensions H x W x D	248 x 152 x 205	310 x 190 x 243	330 x 205 x 253	780 x 205 x 263

*Quad loudspeakers are compatible with all standard 4 and 8 Ohm amplifiers

L2 Series

What's in the Box?

9L2; 11L2; 12L2

The packaging contains the following items:

- o One pair of L2 loudspeakers
- o This Instruction Manual
- o Warranty Registration Form
- o One pair of cotton gloves

L2 Centre

Each carton contains the following items:

- o One L2 Centre loudspeaker
- o This Instruction Manual
- o Warranty Registration Form
- o One set of four adhesive feet (attached to the underside of the cabinet)
- o One pair of cotton gloves

21L2; 22L2

Each carton contains the following items:

- o One L2 loudspeaker
- o This Instruction Manual
- o Warranty Registration Form
- o One Spacing Plate (fitted)
- o Four mounting screws
- o One Plinth
- o One set of four spiked feet
- o One pair of cotton gloves

Consult the dealer from whom you purchased the equipment if any of these items is not present.

Please retain the packing materials for future use or return them to your dealer. If you decide not to keep the packing, please dispose of it having regard to any recycling regulations in force in your area.

Please retain the user manual and the information concerning the date and place of purchase of this equipment for future reference. In the unlikely event that you pass this product on to a third party, please include all the accessories and this instruction manual.

Troubleshooting

If your system is not working properly please work through this checklist before returning a unit to your dealer. Before investigating a problem, always switch off the system at the mains.

Symptom	Possible Cause
No Sound	System not switched on; Speaker cables shorting terminals out; Wrong source selected
Sound lacks bass content Bass reproduction indistinct	Front loudspeakers out of phase. Subwoofer not switched on; Subwoofer phase incorrect; Subwoofer crossover control too low; Incorrect preset; Subwoofer drive unit obstructed
Excessive bass distortion at low volumes	Subwoofer level set too high; LFE level set too high; Subwoofer incorrectly wired
Excessive or distorted bass at high levels	System level set too high; Bass control set too high; Speakers too close to room corners
Distorted or rattling sounds at high levels	System level too high; Objects on speakers/subwoofer; Objects too close to subwoofer; Unstable/loose flooring below subwoofer
Popping or thumping from the subwoofer	System level set high; Subwoofer level set too high; LFE level set too high
Indistinct sound; Poor localisation of effects. Poor localisation of dialogue	One or more loudspeakers is out of phase (Read the manual for correct connection procedure)
Television picture colour is distorted	Subwoofer too close to TV. (Switch off system and TV. Move units away. Leave 15 mins. Switch on)

Positioning the Loudspeakers

However good the loudspeaker, the final results will depend on the acoustic characteristics of the listening room and the position of the loudspeakers in it. Do not be afraid to experiment with both position and orientation and make a point of trying some of the less obvious as well as the more obvious positions. The benefits obtained from the time spent doing this can be very rewarding. The subject of room acoustics is complex and beyond the scope of this manual. It is assumed that the loudspeakers will be used in a room with moderate reverberation, neither too bright nor over damped. Furnishings can alter the acoustic characteristics of the listening room, and here common sense is the best guide.

When experimenting, it is preferable to use good recordings or works with which you are familiar in the concert hall or good quality speech.

Positioning the 21L2 and 22L2

We recommend that these loudspeakers are placed between two and three metres apart and equidistant from the listening position. The tweeters should be roughly at ear level to a seated listener. The loudspeakers should be positioned so that they are angled slightly inward, facing the listener in a direct line of sight.

Place the loudspeakers on a sound level floor, free from rattles. It is not advisable to operate the loudspeakers across corners, in alcoves or behind furniture.

The most uncoloured sound will be obtained when the loudspeakers are at least 200mm from the rear walls and 300mm from the side walls. If the loudspeakers are operated closer to the rear walls the bass extension will increase but if they are placed too close to the walls the bass may boom and become indistinct. If the loudspeakers are placed further away from the walls, the inward angle may be increased, although this may restrict the width of the optimum listening position.



L2 Series

Connecting Two Subwoofers

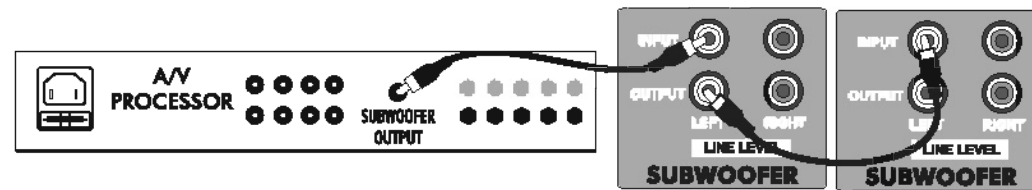

Connection to Quadlink Bus Systems

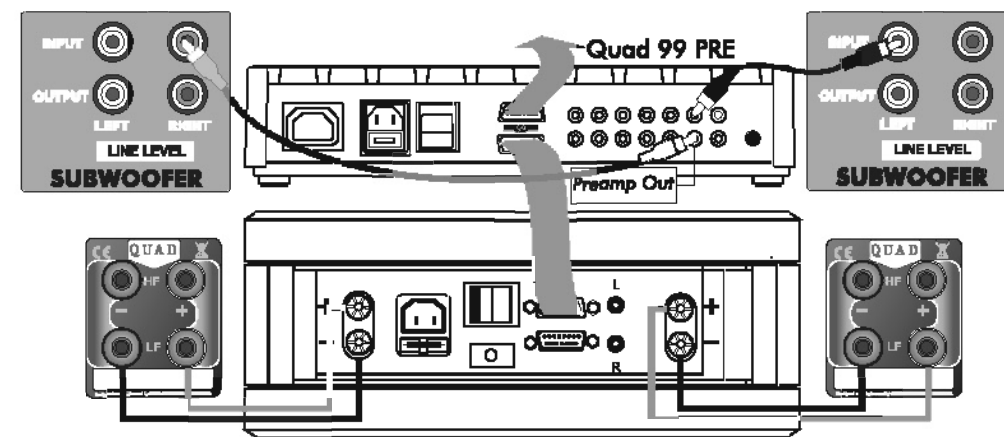

Normal Stereo Connection

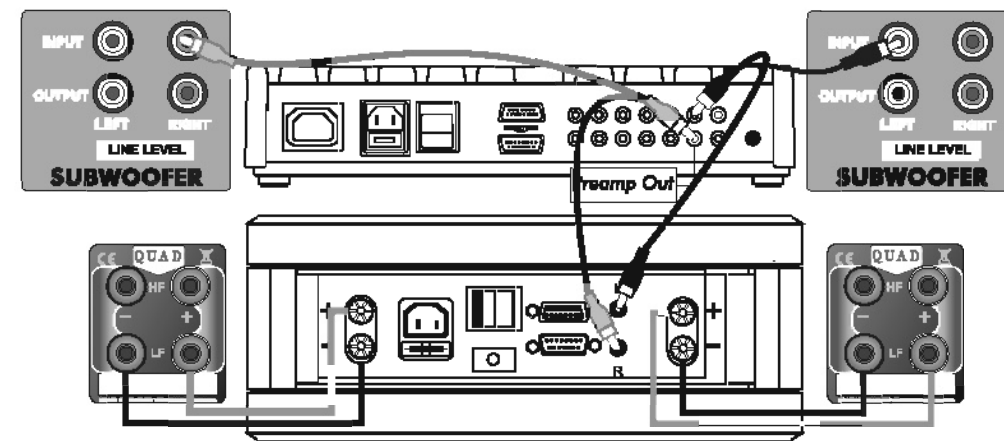

Pre Out/Main In Connection

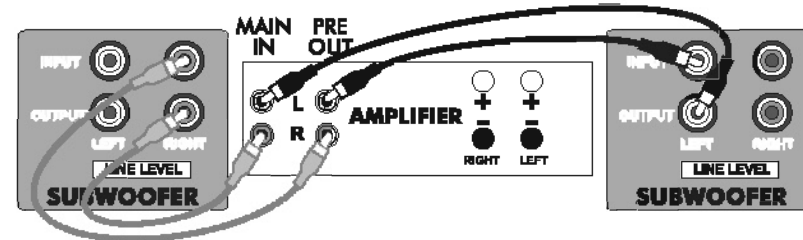

*'Y' Connection may also be used - see previous section

L2 Series

Connections and Terminals

Choosing and Preparing Loudspeaker Cable

Specialist audio cable will usually offer better performance than general purpose 'bell' or 'zip' wire. Audio cable is polarised, with two cores of different colours, or often, in the case of twin cable, a coloured tracer or ridge along one wire to indicate polarity. Choose a cable of suitable diameter - cable that is too thin will limit the dynamics of the sound and may impair the bass response. Split the twin cores to a depth of about 25mm. Carefully strip the insulation from each end, leaving about 7mm of bare wire. If the cable is stranded, lightly twist to gather any loose strands.

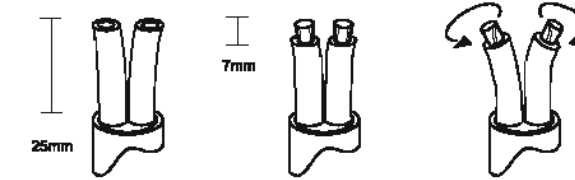

Crossover Network

All loudspeakers in the L2 series use biwired crossover networks for improved fidelity and low insertion loss.

The crossover network separates the treble and bass networks into two distinct sections, each connected by a dedicated pair of terminal posts. This enables the treble and bass components to be separately driven for optimum performance. The upper pair of terminals is connected to the treble network and the lower pair to the bass network.

As supplied, the treble terminal pair is connected to the bass terminal pair by removable metal straps. These should be left in place for standard installations.

Note that the positive (+) terminals are located at the right.

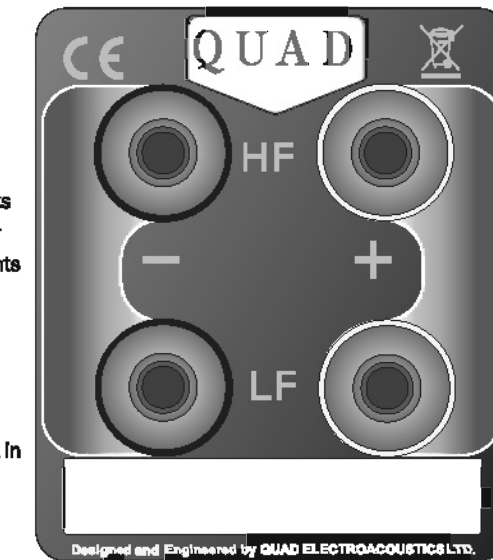

Terminals

Use an equal length of twin core speaker cable for each channel, and prepare the ends as described above. Unscrew each speaker terminal. Thread the bared end of each cable through the hole in the bottom of the terminal post. Ensure that there are no loose strands which may touch adjacent terminals. Retighten the terminal securely.



Before Connecting your Loudspeakers

- Switch off your amplifier and all connected source units at the mains.
- Unplug the power cords to all system components if necessary.
- Before re-connecting your system to the AC power supply, check that all the connections are properly made.
- Check that all speaker terminals are done up tightly.
- Ensure that there are no strands of wire shorting adjacent speaker terminals.

L2 Series

Setting Up Your Subwoofer

Your subwoofer is most likely to be used with two typical programme sources, music and movies. The setup for these two very different sources may be different if best results are to be achieved. Please read these setup notes in conjunction with your processor and speaker manuals.

All setting up of the subwoofer should be performed with tone controls and filters set 'flat'.

Listening Rooms and Subwoofer Positioning:

Listening rooms are not ideal. Most rooms are reverberant with some parallel walls. Because of room geometry and construction there will be areas with severe peaks at some frequencies and severe troughs at others. If you site loudspeakers in such areas the response will be highly non-linear. With subwoofers this situation is exacerbated by the fact that it is easier to treat high frequency irregularities by the use of drapes, soft furnishings etc., but very hard to do the same at bass frequencies due to the very long wavelengths - at 40 Hz the wavelength is almost 9 metres. To help locate standing waves in your listening room, one idea is to sit in the listening seat and recruit a friend with a deep voice to speak as he moves around the area where you propose to site your subwoofer - you will soon find out where *not* to site it! Where the voice sounds most natural is a good place to start.

The low frequency response of the subwoofer and its blend with the main loudspeakers is thus profoundly affected by positioning. Although bass is enhanced by walls or corners, so often is coloration. As the drive unit faces downward, the floor will influence the sound. The surface under the subwoofer should be stable and unobstructed. If the carpet is very thick, consider placing the subwoofer on a solid surface such as a marble slab.

The subwoofer has to blend with the main speakers: if you place the subwoofer where it amplifies the irregularities of the room or the main speakers the result will be bloated, coloured bass. If acoustic guitar and male voice sounds coloured when the subwoofer is operating and less coloured when in standby, you need to address the positioning first before adjusting any controls

Loudspeaker Phasing: Make sure that all loudspeaker channels are connected in phase. Nothing is more certain to defeat a Home Cinema or Stereo setup involving a subwoofer than one(or more) channels being out of phase. In Stereo, if there is a doubt about the way the loudspeakers are connected, check their phasing by playing a mono source - the sound should appear from a point midway between the two loudspeakers. If this position is indefinite, reverse the connections to one of the loudspeakers. Correctly connected loudspeakers give a definite centre sound source with fuller bodied tenor and bass registers.

Setting the Phase of the Subwoofer: Phase at very low frequencies is not straightforward to detect. Initially we suggest you temporarily set the low pass filter to 'off' and the phase to 0° and play some bass heavy music in Stereo through the main speakers and the subwoofer. From the listening position, switch the phase between 0° and 180°. The setting which appears to give the greater bass output is correct. Now follow the instructions below for setting the low pass filter.

Home Cinema Systems

Low Pass Filter: If you are using a digital AV processor the initial setting should be 'OFF' as the processor will have its own bass management system.

Most digital AV Processors ask you to specify the size of speakers in the various channels. These are usually 'Large' or 'Small'. This sets the bass management for the system. Unless your loudspeakers are large floor standing units, you should choose 'Small' for the Front channels, as the subwoofer is going to be better at providing clean, deep bass. Choose 'Small' for the surround channels and also for the Centre channel, so that any bass from these channels will be directed to the subwoofer. Set the 'Subwoofer' option on the processor to 'On' or 'Yes'.

After experimenting with various sources you may need to adjust the LPF settings. The goal is to ensure the subwoofer blends seamlessly into the sound stage. Setting the subwoofer to Standby should reduce the bass extension, not change the bass level - as always personal taste plays an important part.

L2 Series

Connecting Effects Loudspeakers

The Quad L2-Centre is a dedicated centre channel loudspeaker, voiced to blend seamlessly with the other loudspeakers in the L2 Series, though it can be used with any high performance loudspeakers, including Quad ESLs. When partnered with the Quad 21L2 or 22L2 as front channels, and the 9L2, 11L2 or 12L2 as rear effects channels, a Home Theatre system of outstanding performance can be built up.

The 9L2 is a versatile small loudspeaker. It can be used as the front channels, its diminutive size makes it ideal for use as the rear effects channel in multichannel systems.

The connections for a typical Home Theatre system are shown below. We suggest that the Front and Centre Channels are bi-wired. The rear effects speakers should be connected using the standard connection as described above, though you may bi-wire them if you prefer.

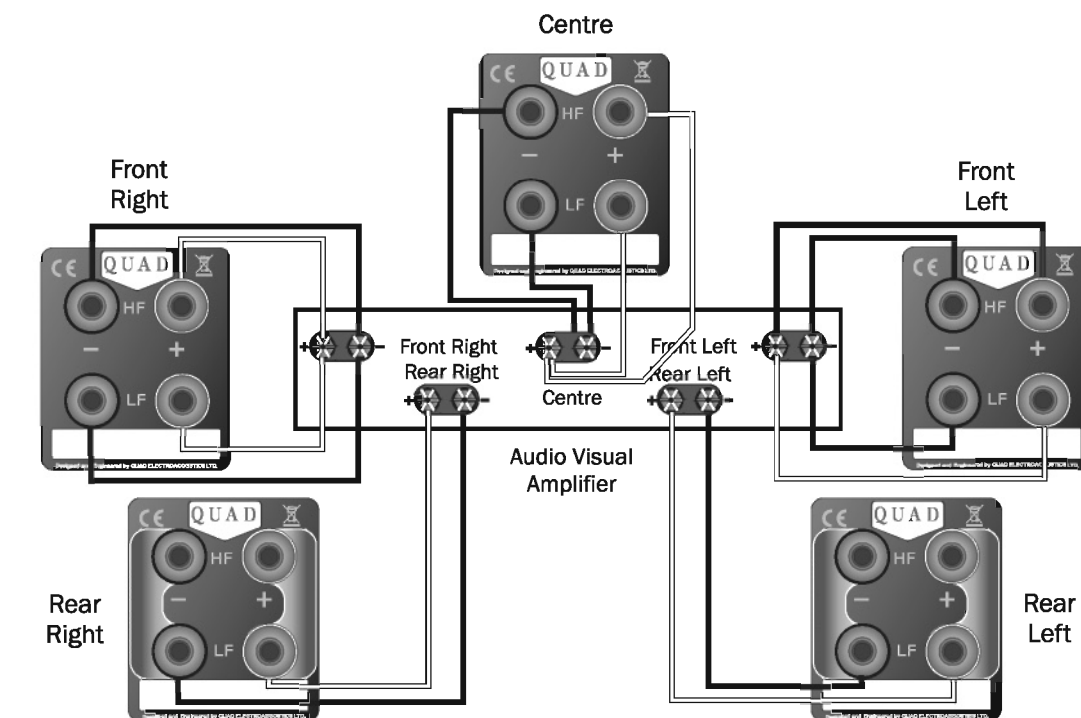

L2 Series

L2 Series

Pre Out - Main In connections

Method A: You will need two screened RCA 'Y' adaptors and two single RCA phono cables.

Remove the Pre-Main links on your amplifier. Connect the socket (common) of an RCA 'Y' adaptor to one of the mono cables. Connect one leg of the 'Y' adaptor to the Left Channel Pre Out socket on the amplifier and the other leg to the Left Channel Main In socket. Connect the remaining plug on this combination to the Left Channel Line Level Input on the sub-woofer. Repeat this for the Right Channel.

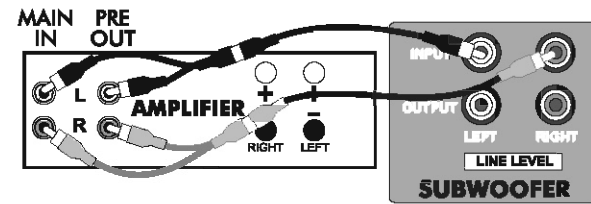

Method B: You will need two stereo (or four single) screened RCA cables.

Connect a Stereo cable from the Line Level Inputs of the subwoofer to the Pre Out sockets of the amplifier. Connect a second Stereo cable from the Line Level Outputs of the subwoofer to the Main In sockets of the amplifier.

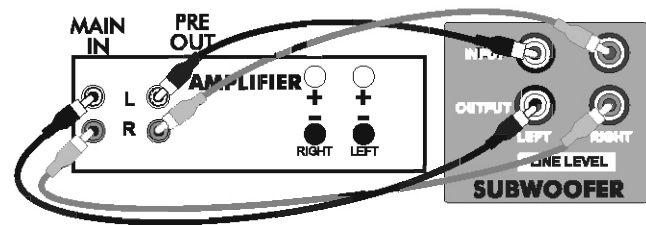

Speaker Level connections

The High Level speaker connections should be used only if your amplifier does not have a line level subwoofer or preamp output. You will need two extra twin core cables.

Using one of the additional twin core cables, connect the Left Speaker Terminals on the subwoofer to the Left speaker terminals of the amplifier. Connect the Red (+) speaker terminal on the amplifier to the Red (+) terminal on the subwoofer. Connect the Black (-) speaker terminal on the amplifier to the Black (-) terminal on the subwoofer. Now connect the Right Speaker terminals on the subwoofer to the Right speaker terminals of the amplifier.

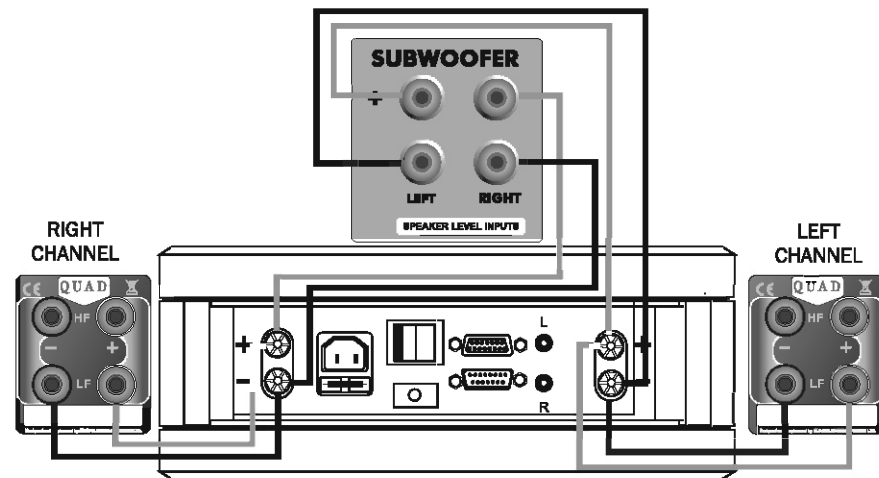

Delay and LFE Settings

The purpose of delay is to enable surround and dialogue information to arrive at the listener's ears at the same time as the Front channels, even when the listening seat is in a non-ideal position.

Rear Delay: If the listening position is equidistant from the Front and Rear speakers, a low delay setting should be set. The closer the listener is to the Rear speakers the higher should be the delay setting used.

Centre Delay: If the Centre speaker is level with (or slightly behind) the Front speakers, set the delay to zero. If the Centre speaker is forward of the Front speakers, increase the delay.

LFE: In domestic systems the LFE channel typically feeds into the subwoofer. Where no subwoofer is used, the LFE signal is combined with Front Channel information. When you set the LFE level at your AV processor, use care as the powerful low frequencies can overload domestic loudspeakers.

If you hear popping or thumping noises coming from the front loudspeakers or subwoofer, immediately turn the AV Processor's volume level down and then back off the LFE level. This should cure the problem. If it does not, back off the volume level at the subwoofer (if you are using one) until the problem disappears.

Please read the relevant sections of your AV amplifier manual and familiarise yourself with the various issues. If you are unsure, consult your dealer for help.

Expanding the System

Dolby Labs, DTS and THX offer 6.1 and 7.1 formats which extend the 5.1 principle by adding one or two extra rear effects channels. Although the precise configuration of these systems will depend on the capabilities of your processor and you should be guided by those instructions, we would make some observations.

For most 6.1 and 7.1 formats the listening seat should not be too close to the rear wall. Optimising the time delay so that information from all speakers arrives at the listening seat coherently is critical if the benefits of these systems are to be fully realised. THX adjustments in particular need to be followed to the letter.

Dolby Labs Recommended 7.1 Placement
(Single Back channel for 6.1 shown dotted)

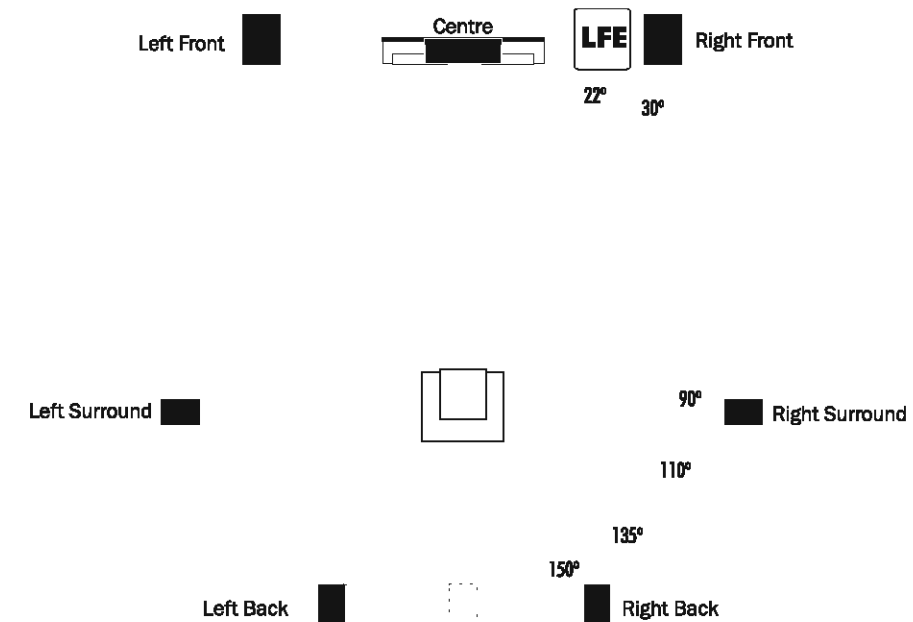

L2 Series

L2 Series

Connecting the L2 Subwoofer

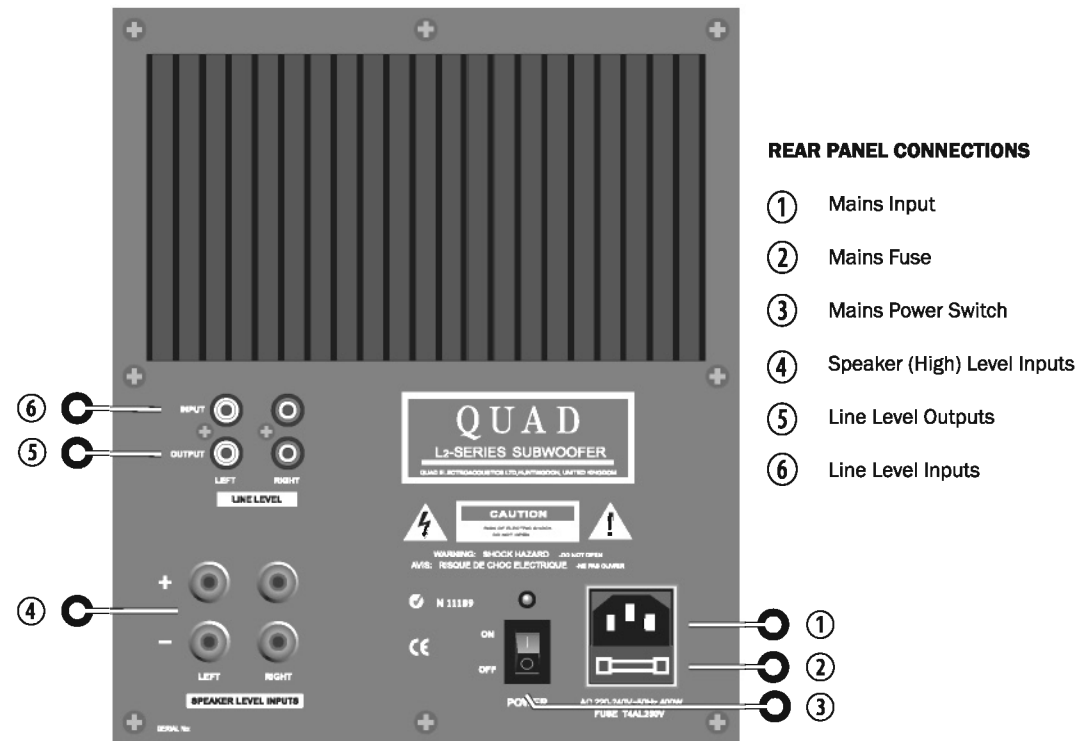

Connecting to a Digital AV Processor

If your AV processor has a line level or LFE subwoofer output you should use this connection. You will need to purchase a single screened RCA phono lead from your dealer. Connect this lead to the Left line input of the Subwoofer as shown below.

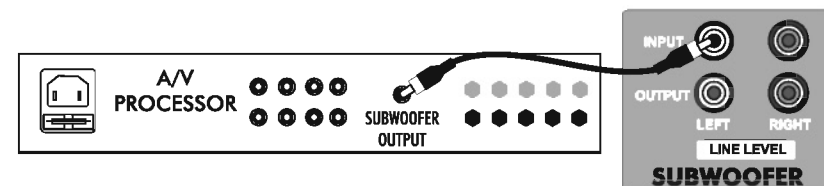

Stereo Line Level Connections

Stereo line level connections will be necessary:

- where there is no dedicated single subwoofer output, but where there is either a stereo subwoofer line output or a separate preamp output.
 - where there is a preamplifier line output, or if an integrated amplifier, a pre/main link that can be separated.
- The output must be controlled by the system volume control - a tape output is not suitable. If you are in doubt, consult your dealer.

Connect a stereo RCA phono cable from the line output of the preamp to the Subwoofer line inputs.

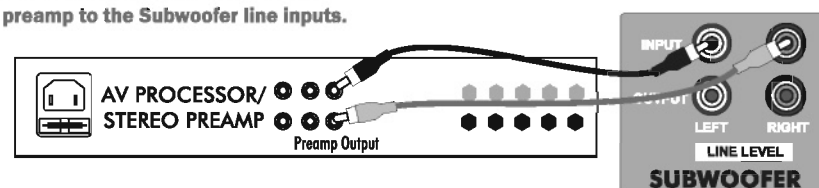

Preparation

Fitting the Feet

- Carefully invert the subwoofer.
- Protect the top by placing it on a soft surface such as a towel.
- Open the polythene bag and slide it part-way down the cabinet.
- Two sets of adjustable screw feet are provided - regular and spiked. Choose one set only - do not use a mixture of spiked and regular feet.
- Screw the threaded washer over each foot as shown.
- Screw a foot part-way into the threaded hole at the bottom of each leg of the subwoofer and hand-tighten the washer.

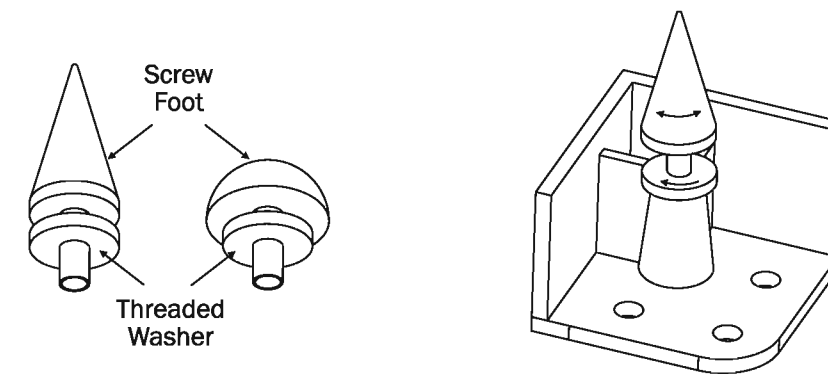

Levelling the Subwoofer

- When all four screw feet have been fitted, stand the subwoofer upright and remove the bag.
- With the aid of a spirit level, screw each foot in and out until the subwoofer is level (side to side and front to back) and firmly supported on all four feet.
- Tighten the washer with a suitable wrench to lock the assembly in position.

Note: When using spiked feet take care not to drag the subwoofer and be careful not to pierce objects or cables which may be hidden under carpets, etc. Spikes are not suitable for use with stone floors and can cause damage to wood floors, so consider carefully before deciding which feet to use.

Installing Batteries in the Handset

The handset operates on two LR6 (AA) batteries which are supplied. The battery compartment is located at the rear of the handset. Unwrap the batteries and slide the cover off the handset. Place the batteries in the handset observing the polarity. The correct orientation is shown on the diagram. When the batteries are installed, replace the cover.

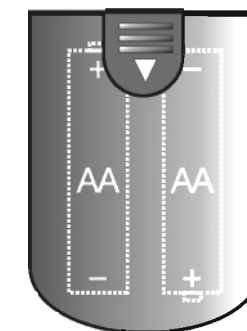

L2 Series

Connectors and Cables

You should ensure that cables which are used with Quad equipment are properly terminated and appropriate to the task. This is particularly important with loudspeaker cables and connections. If you are in any doubt consult your dealer.

When routing any cables to loudspeakers do not run them across open floor spaces where they may cause danger to people and pets. Route them safely, around room boundaries if necessary.

Loudspeaker cables

Loudspeaker cables should be carefully prepared. When stripping the insulation, be careful not to cut into the wire. Make sure that you collect together all the strands of wire as stray wires may cause shorting which could result in damage or cause a fire.

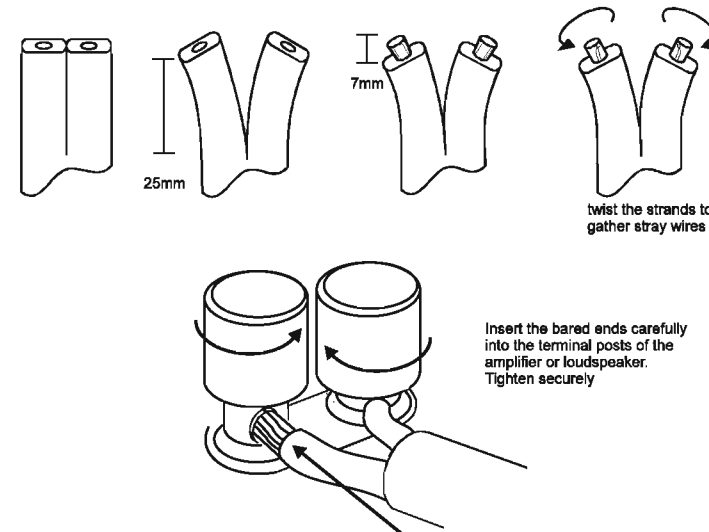

When estimating the length of loudspeaker cable, provide sufficient to enable access and tidy securing. Some cables are quite heavy and should be placed so that they do not cause undue strain on the binding posts of the subwoofer.

Signal Cables

Signal cables should be properly terminated and fully screened to minimise hum. If you connect your subwoofer via the low level signal inputs, the cable between your control unit or processor and the subwoofer could be quite long so screening is particularly important. Consult your dealer if in doubt.

L2 Series

Positioning the subwoofer

Although the unit may be placed almost anywhere in the room, we recommend that it be placed in front of the listener and as central to the listening position as possible. As the subwoofer is a powered unit there should be a mains outlet within easy reach. The subwoofer should not be operated within 450mm of a conventional CRT television set as the drive unit magnet may distort the picture. Remember that there should be a line of sight between the listening position and the front of the subwoofer otherwise the remote functions will not be operable.

We suggest you initially position the subwoofer about 20cm (8 inches) from the wall. Placing the unit close to the wall will enhance the bass; placing it across the corner of the room will increase the bass further, possibly at the expense of clarity. Do not place the subwoofer close to surfaces or objects that may rattle. The floor under the subwoofer should be sound with no loose floorboards, etc.

You should expect to experiment with a variety of locations and sources before making a final decision.

Checking the AC power supply

The Quad L2 subwoofer is supplied in versions suitable for connection to 230V, 220V, 115V or 100V AC power supplies.

Before connecting to the AC power supply, check that the voltage range marked on the back corresponds with that of the supply. Please check with the dealer if you have any doubt as to the voltage in your area or intend to use the equipment in regions which use other mains voltages.

Fuses

The mains supply fuse of the subwoofer is accessible on the rear panel after the IEC mains plug has been removed. In the rare event that it has broken, you should first check for any obvious cause before replacing the fuse with one of the correct rating and type. The correct fuse values are:

220 - 240V (UK, Korea, etc.) T 4 AL 20mm Slow Blow
100- 120V (USA, Japan, etc.) T 8 AL 20mm Slow Blow

You should switch off the equipment and remove the connection to the mains power outlet before changing the fuse.

Before Connecting the Subwoofer

- o **Switch off your amplifier and all connected source units at the mains.**
- o **Unplug the power cords to all system components if necessary.**
- o **Make sure the subwoofer is disconnected from the mains and that the ON/OFF switch is OFF.**
- o **Before re-connecting your system to the AC power supply, check that all the connections are properly made.**
- o **Check that all speaker terminals are done up tightly.**
- o **Ensure that there are no strands of wire shorting adjacent speaker terminals.**

L2 Series

L2 Series

The Quad L2 Subwoofer

Introduction

The Quad L2 subwoofer is primarily intended for use with very high quality sound reproducing systems in the home and we hope that they will give you much pleasure. The subwoofer will very probably be used in conjunction with Quad amplification though any quality home cinema equipment can be used.

You should read the following notes before you begin to install and use the equipment. The notes are directed towards responsible adults who can ensure safe installation of the equipment. Minors should not attempt electrical installation or carry out changes.

The subwoofer is very heavy and robust. Remember to check that any surface on which you place it is stable and able to support this weight.

There are no user adjustable parts inside the equipment. You should refer any servicing to a qualified engineer or return the equipment to either the dealer or the Quad distributor.

What's In the Box?

The packaging contains the following items:

- One L2 Powered Subwoofer
- One IEC mains lead fitted with an appropriate mains connector for your country
- Instruction Manual
- Warranty Registration Form
- Remote Control Handset plus two LR6/AA batteries
- 4 adjustable standard feet
- 4 adjustable spiked feet
- One Pair Cotton Gloves
- One cardboard carton and packing materials

Consult the dealer from whom you purchased the equipment if any of these items are not present.

Unpacking

Open the carton and remove all the top packing pieces. Lift the subwoofer out taking care not to damage the cabinet. When lifting the unit from the carton support it from the bottom. DO NOT attempt to lift the subwoofer out of the carton using the polythene bag.

The unit is heavy; if you cannot manage it easily, get someone to assist you.

Retain the packing materials for future use or return them to your dealer. If you decide not to keep the packing, please dispose of it sensibly. The paper and plastics are recoverable and may be taken to an appropriate recovery service.

Please retain the user manual and the information concerning the date and place of purchase of this equipment for future reference. If you transfer this equipment to a third party, please ensure all the instructions are passed on with the product.

Connecting to QUAD Amplification

Method A

Use this method:

- where a Quad control unit is connected to the power amplifier using the QUADLINK system - this will be found on 77 and 99 series systems only.
- If you have a Quad 77 integrated amplifier (whether you use QUADLINK or not) or a preamplifier or integrated amplifier with a spare (unused) preamplifier output.

Connect the control unit to the subwoofer using a good quality RCA screened stereo cable as shown below.

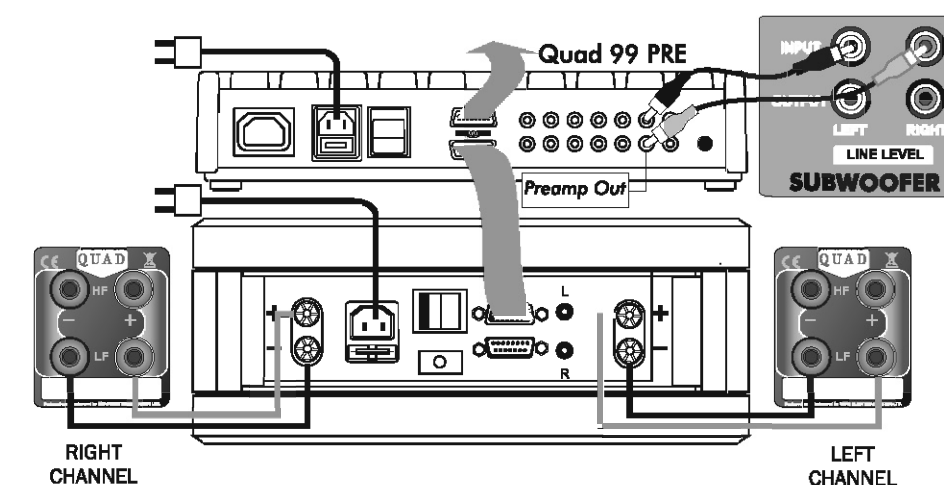

Method B

Use this method:

- where a Quad control unit is connected to the power amplifier via RCA phono connectors.

You will need two 'split mono' leads - a single phono plug connected to two phono plugs. Connect the leads as shown in the diagram below taking care not to mix up the channels.

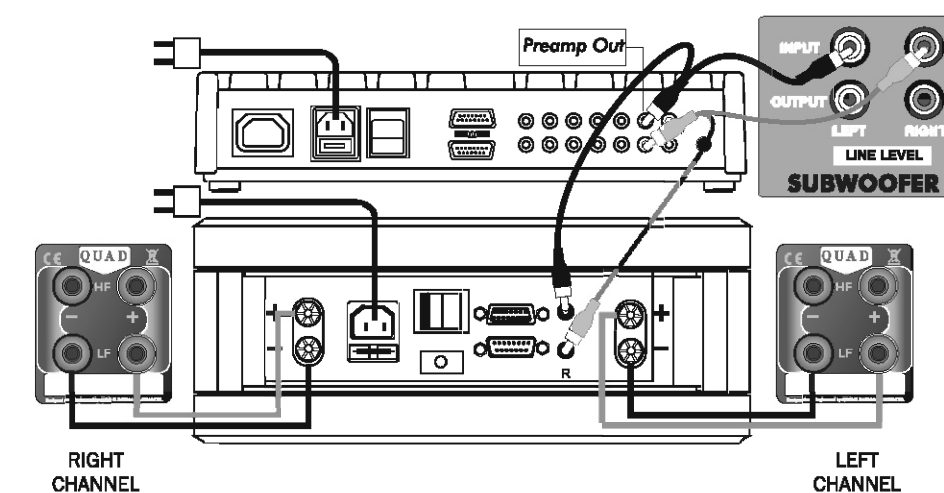

L2 Series

Setting Up a Home Theatre System

Placement

Front And Effects Channels

The front loudspeakers are placed on either side of the television screen, 2 to 3 metres apart. The speakers should be angled slightly so they are aimed towards the listeners.

We recommend placing the rear effects speakers in a high position, behind the listener's head. If the rear or side walls are a long way from the listening seat, consider stand mounting the loudspeakers. If the centre loudspeaker is very high or low, angle it towards the listener's ear level. The front faces of the centre and surround loudspeakers should also be in line as far as possible.

Subwoofer

As the ear is unable to detect the direction from which deep bass originates, this allows you freedom to position the unit. Varying the distance from the wall alters the bass. Placing the subwoofer across a corner boosts the bass but may impair clarity. The performance of Home Theatre systems can often be enhanced by using a pair of subwoofers.

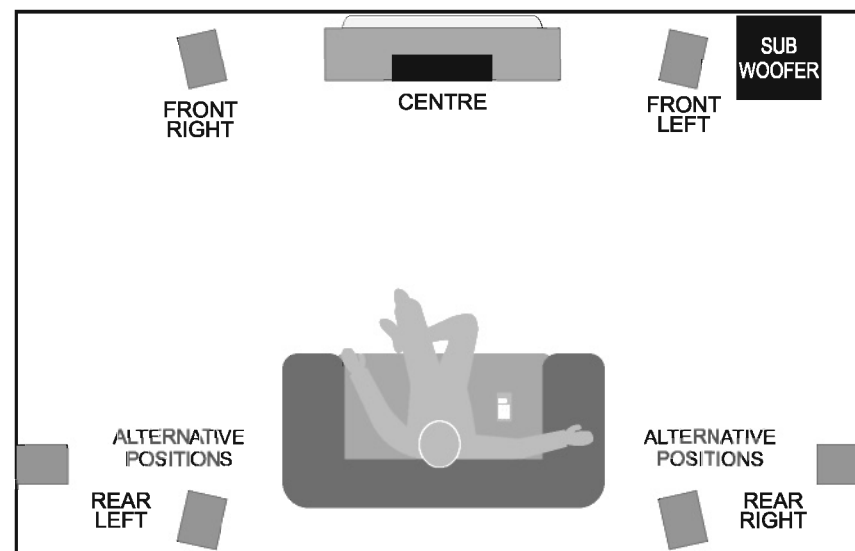

Setting Loudspeaker Sizes

Many digital AV Processors ask you to specify the size of speakers in all channels - usually 'Large' or 'Small'.

The L2 Centre should be set to 'Small' as should the bookshelf units. The surround channel speakers should be set to 'Small'. The 21L2 and 22L2 may be set to 'Large' or 'Small' - try both and see which setting works for you.

If you are not using a subwoofer: Set the Front Speakers to 'Large'. Set the 'Subwoofer' option on the processor to 'Off' or 'No'. The Front channels will now receive all the system bass.

If you are using a subwoofer: Those loudspeakers which are set to 'Small' will have their bass diverted into the subwoofer. Those loudspeakers which are set to 'Large' will reproduce the full range.

Once the loudspeaker settings have been finalised, put the AV amplifier into its "Test" mode (see instructions supplied with your processor). Adjust the level of each channel until all channels are reproduced at equal loudness.

You may need to adjust the subwoofer output level. Avoid setting too high a level or you will swamp the sound with bass and may limit the subwoofer's ability to respond to large bass transients. You should also set a sensible level going into the subwoofer from the AV processor.

L2 Series

Operation

Switching On

Check that all connections to the subwoofer have been properly made and that the main volume control is at minimum. Plug the supplied power cord into the mains socket on the rear panel.

Plug in the mains plug and switch the power on. Now switch the subwoofer on with the rest of your system.

The subwoofer on/off switch has a rocker action; press the upper part to switch the equipment on and the lower part to switch it off. When switched on the light above the power switch will glow and the subwoofer will be operational.

Operation - Controls and Functions.

All control functions are carried out using the remote handset. The handset must be pointed at the subwoofer and be in line of sight for it to operate.

Standby: Operating the Standby key brings the subwoofer in and out of Standby.

The drawing on the right shows a typical front panel display during operation.

The preset light will not light if no preset has been set up or if a preset has been over-ridden.

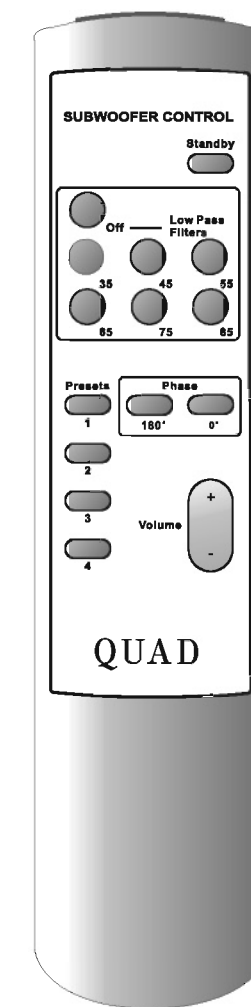

In Standby, the Volume, Filter, Preset and Phase indicators are extinguished. The POWER and the rear panel lights remain on.

Volume: Press the Volume + key to increase the volume level. Press the Volume - key to decrease the volume level of the subwoofer. The volume range on the front panel display varies from 00 (minimum) to 99 (maximum).

Low Pass Filters: Pressing the appropriate filter key will select the frequency at which the subwoofer rolls off. The filter has steps at Off and 35Hz-85Hz in 10 Hz increments. When 'OFF' is selected the subwoofer operates over its full designed range. Pressing other keys lowers the maximum operating frequency. The Low Pass Filter value should be chosen having regard to the nature of the Front speakers and programme material. Follow the Setup Notes on Page 11 and the instruction manual of your AV processor (if used) for more guidance.

Phase: This key toggles the subwoofer between 0° and 180° phase shift.

Presets: Four different settings of level, frequency and phase can be stored. Pressing and holding any of the preset keys on the remote for 3 seconds will cause the current settings to be stored in that preset. The display will show the preset number then flash the preset number once to show it has stored the preset.

To change from one preset to another: Press a preset key on the remote for less than 3 seconds to recall the settings of that preset. The display will show the preset number:

If you select a preset and then alter any aspect of the setup, the preset light will extinguish (as the setup no longer matches the preset).

Note: When brought out of standby for the first time, the unit will display the factory presets. Thereafter, bringing the unit out of standby will revert it to the operational state last used. If you switch the power on and off at the rear panel while the unit is in standby, the unit will power up to a normal operating state (i.e. not in standby). To enter standby, again press the Standby key.

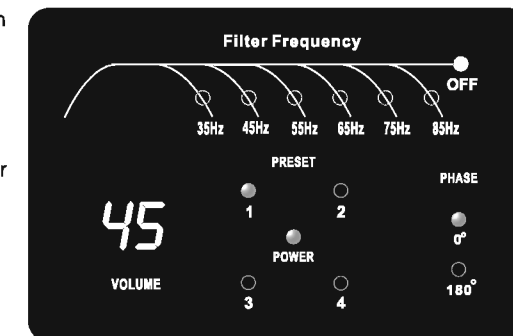

L2 Series

L2 Series

Stereo Connections

Standard Connections

Choose a suitable length of twin core speaker cable for each channel. Connect the positive (+) terminal of the Left loudspeaker to the corresponding positive(+) amplifier terminal. Connect the negative (-) terminals similarly. Repeat this procedure for the Right Channel. Do not disturb the metal straps linking the upper and lower terminal pairs

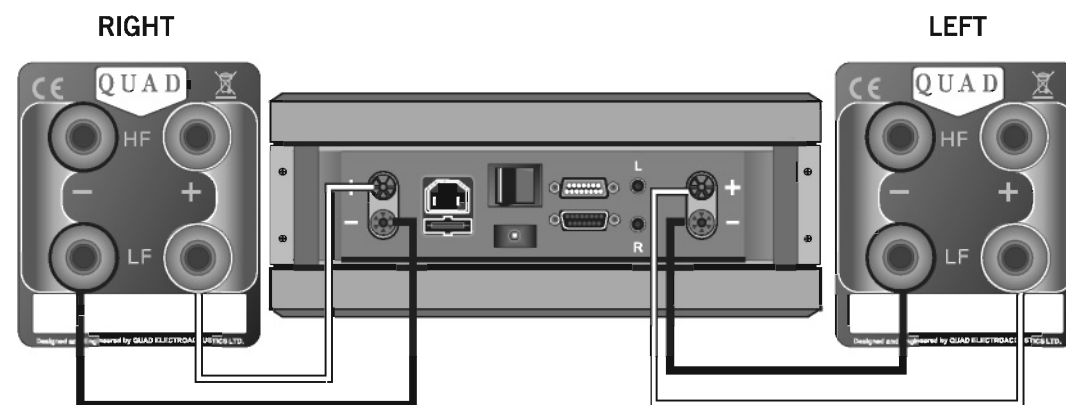

Bi Wired Connections

Most of the audio signal going to the speakers drives the bass units. Where one cable feeds both bass and treble units, this heavy bass current can modulate the high frequencies. Using separate cables for treble and bass units reduces intermodulation effects and improves headroom and clarity. This is known as Bi-Wiring. To bi-wire, you will need to install two lengths of twin core cable between the amplifier and each loudspeaker.

Unscrew each terminal a few turns and remove the metal straps. The upper pair of terminals on the crossover panel feeds the treble units and the lower terminals feed the bass unit. Connect the cables between the amplifier and the loudspeakers as indicated above and re-tighten all the terminals securely. Where feasible, we strongly advocate bi-wiring.

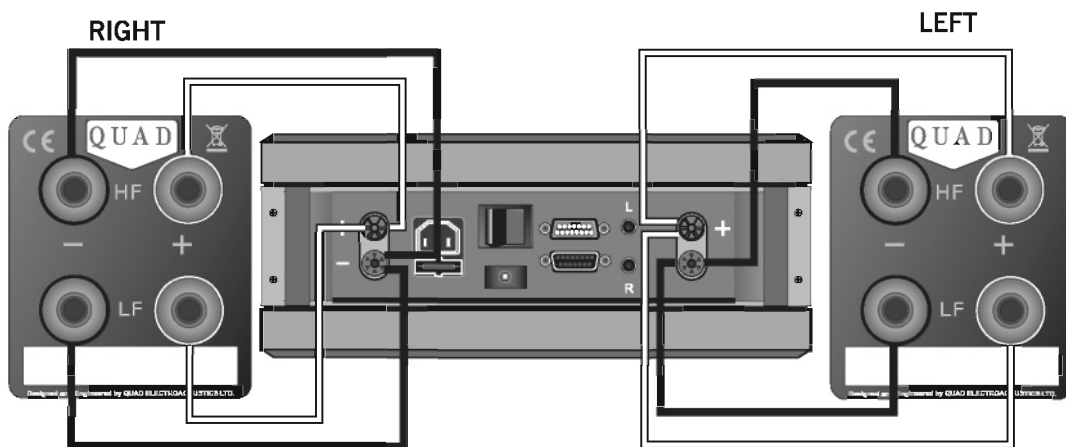

Bi-Amplification (Bi-Amping)

By connecting each loudspeaker drive unit to its own dedicated amplifier the advantages of Bi-Wiring can be extended. If you own two identical stereo power amplifiers, you may wish to try bi-amping your loudspeakers. For further details please consult your dealer.

Setting levels:

Once the loudspeaker settings have been finalised, put the AV amplifier into its "Test" mode (see instructions supplied with your processor.) Adjust the levels until all channels are reproduced at equal loudness.

In order to leave the L2 subwoofer some headroom, the volume display should be around 50 at normal listening levels. To achieve this you may need to adjust the subwoofer output level from your AV processor to compensate.

LFE: This channel was originally an additional bass channel with its own dedicated subwoofer. In practice however, if any speakers are set to 'Small', the LFE channel is combined with the bass from those channels and fed into the subwoofer. When you set the LFE level from your AV processor, use care as the LFE channel contains powerful low frequencies which, although normal in a cinema, may overload a domestic subwoofer. If, during a programme, you hear popping or thumping noises from the subwoofer, turn the AV Processor volume level down and back off the LFE level. If this does not cure the problem, lower the subwoofer volume level.

Note: If any channels are set to 'Small' the subwoofer must be on when the system is playing otherwise there will be reduced bass, as well as no LFE.

Stereo Reproduction

Low Pass Filter: The low pass filter should be set having regard to the size and low frequency extension of the main speakers. The role of the subwoofer is to extend the bass response of the system not to increase the overall bass level. If the loudspeakers are large the LPF should be set low, a value around 45-55 Hz is a good place to start. With smaller speakers this can be increased, up to 85Hz for very small bookshelf units. As always the final value is determined by listening.

Low-level listening: Our ears are far more sensitive to midrange frequencies (2-5 kHz) than bass frequencies. Very low bass and especially percussive bass is 'felt' rather than heard. At low sound levels bass frequencies appear to attenuate faster than midrange and treble. As the level increases this bass roll-off decreases and at loud volumes is negligible. The pioneering work was done in the 1930's by Fletcher and Munson who produced a series of 'Equal Loudness Contours'. Occasionally we may wish to listen to a normally loud piece of music at a low level but with retention of the bass information. The slope control on Quad pre-amplifiers compensates to some extent but there may be a case for assigning a preset for low level listening where the subwoofer volume is set somewhat higher and the LPF is set somewhat lower - as always this is for individual judgement.

Testing the System

By Ear: The simplest way to test the system is to play, at a moderate level, music with deep consistent bass. Switching the subwoofer in and out of Standby should cause change of the depth of bass, and the ambience will also alter. If there is a significant change in bass volume, or a noticeable step in the bass response, or an increase in coloration when the subwoofer is playing, the setup needs to be refined further. By entering different settings in different presets, you will be able readily to identify the most favourable combination.

Using an SPL Meter: This is done with a test disc or signal generator and is beyond the scope of this handbook except to observe that SPL meter settings are weighted 'A', 'B' and 'C' - these correspond to the inverse of the Fletcher-Munson Equal Loudness Contours at 40, 70 and 100dB. For normal listening levels the SPL meter is usually set to 'C' and the response set to slow. If you wish to use this setup method you should definitely seek your dealer's advice beforehand.

L2 Series

Positioning the 9L2; 11L2; 12L2

The loudspeakers should ideally be placed on stands and angled slightly inward towards a central listening position. The ideal distance will be found by experimentation but as a guide the speakers should be as far apart from each other as each speaker is from the listener. Stand mounted loudspeakers should be placed at least 20cm (8") from the rear wall of the listening room. Placing the loudspeakers close to the rear walls will increase the bass response but may introduce colouration at low and low-mid frequencies. To preserve the outstanding polar response of these loudspeakers, the rear wall should be solid, preferably plastered brick.

If stand placement is not possible the loudspeakers may be mounted on sturdy shelves or wall brackets. The 9L2 is provided with standard omnimount fixings and suitable brackets are available from your QUAD dealer.

As a general rule the centre of the tweeters should be at ear level to a seated listener. It is not advisable to operate the loudspeakers across corners, in alcoves or behind furniture.

Positioning the L2 Centre

The loudspeaker should be positioned central to the television and mounted either above or below the screen. Locate the loudspeaker on a stable flat surface to avoid any danger of the cabinet moving when it is vibrated by high sound levels.

If you mount the unit on top of the television, move it forward so that the front grilles are level with or slightly in front of the screen. This will reduce reflections from the screen and the top of the cabinet.

If you are using a Plasma or LCD screen you should place the loudspeaker on a separate shelf or consider wall mounting.



L2 Series

Speaker Level Connection

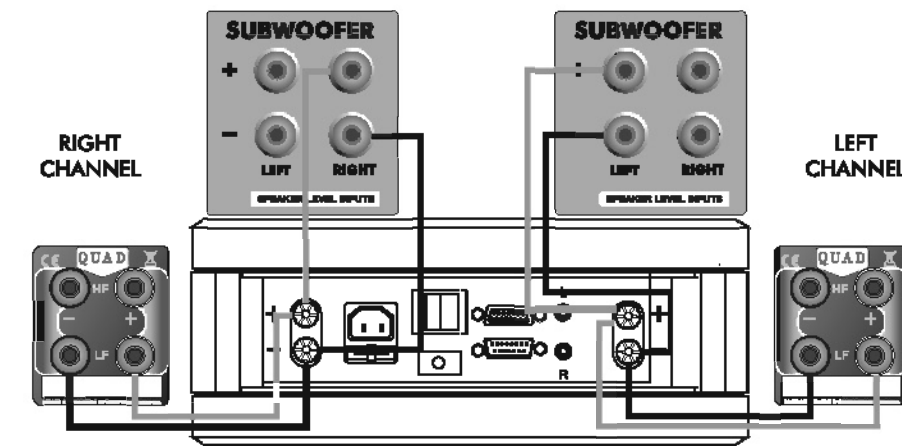

Setting Up Two Subwoofers (General Notes)

- Subwoofers should be sited so that they enhance the system bass response but do not cancel each other out.
- A well-sited pair of subwoofers for stereo applications will be adequately sited for Home Cinema applications.
- A well-sited subwoofer pair raises the bass level 6dB when operating in mono (Home Cinema) but not in Stereo.
- Both subwoofers should be in line of sight to the listening seat as both will answer to one remote handset.
- When operating two subwoofers do all setups and operations on one handset
- Allocate the same preset to each subwoofer, e.g. Home Cinema on preset 1 on both subs, etc.

Home Cinema:

- As AV Processors produce a common subwoofer channel considerations of Left and Right do not apply, but with spaced subwoofers each helps to fill in the troughs caused by in-room standing waves, smoothing the bass and giving the sound greater intensity, 'air' and depth.
- Set up the position of each subwoofer separately with the other one switched off. After you have set both subwoofers up, reduce the front panel volume level of each subwoofer by 3 points.
- Complete the final adjustment with both subwoofers switched on. You may need to make some small adjustments to the position of each sub for best results. We suggest you enter this final setting as a Home Cinema preset.

Stereo:

- Each subwoofer should be located as near as possible to its partnering loudspeaker having regard to placement constraints.
- The smaller the main speakers, the more necessary this becomes.
- It is easier to set up each subwoofer with a mono source playing through one channel with the other channel turned off.
- Complete the adjustment by ear using a mono source with both channels and subwoofers operational. We suggest you enter this setting as a Stereo preset.

L2 Series

L2 Series

L2 Passive Speakers

These loudspeakers are heavy! It may need two people to lift and manoeuvre the larger loudspeakers into position. If you cannot manage the task unaided, enlist the help of a friend.

Always use the supplied cotton gloves when handling exposed surfaces.

Before you unpack the loudspeakers, ensure that you have a large and completely clear area of floor on which to work. Remove or protect any fragile carpets, etc to avoid any damage.

Unpacking

Remove the top packing. Lift the loudspeakers from the packaging. Do NOT lift the loudspeakers with the protective polythene sleeve - support the loudspeaker properly.

Remove the polythene sleeve.

The 21L2 and 22L2 should now be fitted with their spiked feet.

The 9L2, 11L2 12L2 and L2 Centre loudspeakers need no adjustments

Fitting the Plinth to the 21L2 and 22L2

- Place a soft cloth under the speaker.
- Gently invert the loudspeaker.
- Line up the four holes in the plate with the mounting holes in the loudspeaker base.
- Place the plinth over the spacing plate.
- Screw the plinth firmly to the base with the screws.

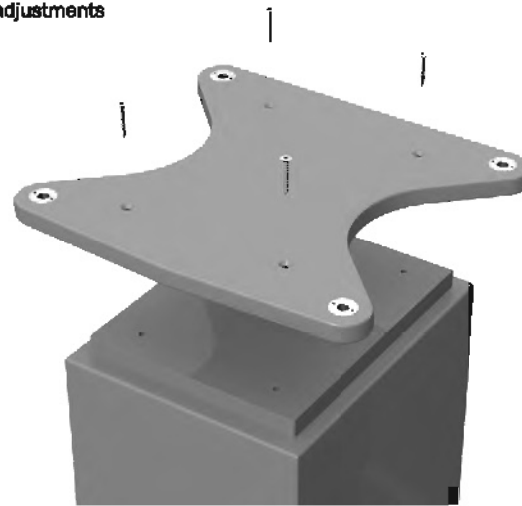

Fitting the Spikes

- Spin the locking ring onto the spike thread until it reaches the spike
- Do not tighten the locking ring just yet
- Thread the spike two-thirds of the way through the plinth.
- Thread the top cap over the spike and tighten it finger tight
- Spin the locking ring down and tighten it finger tight against the plinth.
- Repeat until all four spikes are assembled

Levelling the Loudspeaker

- Stand the speakers upright.
- Loosen the top cap.
- Loosen the locking ring slightly.
- Adjust each spike in and out until the loudspeaker is level.

When the speaker is level all round:

- Lock the locking ring firmly against the plinth mount.
- Tighten the top cap down.
- Make sure all the spikes are firmly tightened.
- Stand the speakers upright.

Warning: Spikes can be Dangerous!

- DO NOT DRAG spiked speakers - lift them!
- Spikes may damage wooden and stone floors.
- When placing spiked speakers on a carpet, make sure that there are no objects or cables under the carpet that could get damaged.
- NEVER let children handle spikes.

Service and Warranty

Warranty and Product Registration

Quad equipment is warranted against any defect in material and workmanship for one year from the date of purchase (proof of purchase is required). We ask that you complete and return the enclosed Warranty Registration Form.

Within the guarantee period, Quad will undertake replacement of defective parts free of charge provided that the failure was not caused by misuse, accident or negligence. Your statutory rights within the territory in which you purchased the equipment are not affected by this guarantee.

There are no user replaceable or serviceable parts inside Quad units. Unauthorised attempts to service or modify Quad products will invalidate the warranty.

Service Arrangements

Equipment for servicing should be returned to the supplying dealer, or to the appointed service agents for your area. The addresses of Service Agents for the UK and the USA and Canada are listed below. If you are abroad and there is no suitable dealer in your area, please contact the distributor for the country in which it was purchased or Quad Electroacoustics Ltd.

Equipment returned for service should use the original packing. Please enclose a brief note with your name and address and the reason for returning the unit.

Authorised QUAD Service Centres in the U.K. and North America

U.K.
QUAD Electroacoustics Ltd.
IAG House, Sovereign Court,
Ermine Business Park,
Huntingdon,
Cambs PE29 6XU,
England.
Tel: +44 (0)1480 447700
Fax: +44 (0)1480 431767

USA
Taiga LLC
310 Tosca Drive
Stoughton,
MA 02072
Tel: 781-341-1234
Fax: 781-341-1228
Email: service@taigallc.com

A worldwide distributor list is available on the QUAD website: www.quad-hifi.co.uk

L2 Series

L2 Series

Good Practice Guide

Before connecting and using your loudspeakers, please bear the following points in mind:

- Switch off the amplifier and all sources before making connections to your sound system. When you switch on the system or change sources, set the volume control to minimum and turn up the level gradually.
- The position of your Volume Control is NOT a reliable guide as to the maximum capabilities of your sound system. Playing the system with extreme settings of volume and tone controls may damage the amplifier and loudspeakers.
- Do not connect loudspeaker terminals to the mains supply.
- Ensure that your loudspeakers are correctly wired and are in phase. Do not subject your loudspeakers to excessive cold, heat or sunlight.
- WARNING:** To reduce the risk of fire or electrical shock do not expose this product to rain or moisture. The product must not be exposed to dripping and splashing and no object filled with liquids - such as a vase of flowers - should be placed on the product.
- No naked flame sources - such as candles - must be placed on the product. Do not place heavy objects on top of loudspeaker cabinets. If you play the loudspeakers with the grilles removed be careful to protect the drive units from children and pets.
- Do not use makeshift stands. Always fit a manufacturer's approved stand using the instructions and the fixings provided. Your dealer will advise you.
- Do not attempt to dismantle the loudspeaker. There are no user serviceable parts inside and you will invalidate the warranty.
- Site regular loudspeakers at least 0.5m away from TV sets and magnetic storage media. The L2 Centre and 9L2 loudspeakers are screened and may safely be operated close to a TV set.
- When connecting your loudspeakers, do not run cable across areas of open floor where they may be a source of danger. Run them safely, around room boundaries if necessary.



22L2

2.5 Way
6.5" 170mm
6.5" 170mm
1" 25mm
6 Ohms*
30Hz-28kHz
32kHz
89dB

150 Watts
50-300W
ported / sealed
35Hz
150Hz,3.0kHz
15 & 25mm MDF

D698
D697
D695B
850 x 205 x 278



L2 Centre

2 Way
5" 125mm x 2
1" 25mm
6 Ohms*
90Hz-35kHz
32kHz
88dB

70 Watts
30-120W
sealed
60Hz
2.0kHz
15 & 25mm MDF

D691
D695D

163 x 428 x 206



L2 Sub

Transducer Complement
Cone Bass driver
Amplifier Output Power (RMS)
Line Input sensitivity
Input impedance
Frequency response (boundary)
Low frequency limit -10dB
Avg. max output @ 1m
Crossover Range

Single Tri-Lam Driver
12" 300mm
300 Watts
250mV for 100W output
10 kOhms
25Hz-95Hz
32kHz
113dB
35 - 85Hz
sealed
15 & 25mm MDF

Component part numbers
Bass driver
Product dimensions H x W x D

D402
535 x 345 x 465